

Use & Care Manual

Wall Mounted Electric Fires

These instructions are for your safety. Please read through them thoroughly before use and retain for future reference. Failure to follow them could cause injury and/or property damage.

Note: This manual applies for a number of different products. Please make sure you follow the appropriate product guide lines.

FIRE IDENTIFICATION

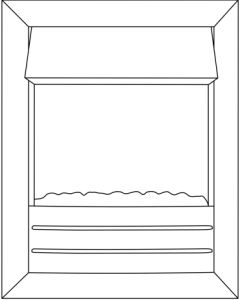
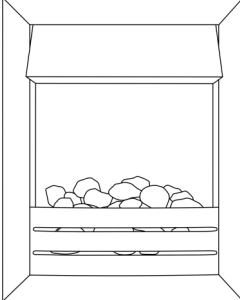
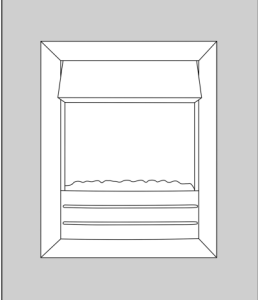
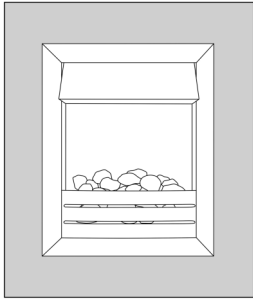
FIRE TYPE	FIRE EFFECT	
A		
	<p align="center">Flame Effect (Wall Hanging)</p>	<p align="center">Pebble Glow (Wall Hanging)</p>
B		
	<p align="center">Framed Flame Effect (Wall Hanging)</p>	<p align="center">Framed Pebble Glow (Wall Hanging)</p>

INTRODUCTION

Thank you for choosing this Electric Fire. The fire is designed to meet the most stringent quality, performance, and safety requirements. This guide aims to improve your understanding and appreciation of your new fire by providing simple and informative assembly instructions.

CONTENTS

Fire Identification	1
Introduction	1
Handling	2
Unpacking	2
Fixings Pack	3
Parts Supplied	3
Electrical Specification	4
Maintenance	4
Safety Cut-Out System	5
Cautions	5
Installation	6
Fire Preparations (Pebble Glow Fires Only)	7
Operating the Fire	7
Changing the Bulb – Pebble Glow Fire	8
Changing the Bulb – Flame Effect Fire	9
Plug Replacement	10
Appliance Data	10
Certifications	11

HANDLING

Before continuing any further with the installation of this fire please read the following:

- When lifting always keep your back straight. Bend your legs and not your back.
- Avoid twisting at the waist. It is better to reposition your feet.
- Avoid upper body / top heavy bending. Always bend from the knees rather than the waist. Do not lean forward or sideways whilst handling the fire.
- Always grip with the palm of the hand. Do not use the tips of fingers for support.
- Always keep the product as close to the body as possible. This will prevent unnecessary and undue strain on the body.
- Use gloves to provide additional grip.
- Always use assistance if required.

UNPACKING THE PRODUCT

The unit is supplied in a single package carton. Carefully unpack the product using the following procedure:

- Carefully lift the pieces out of the box
- Carefully remove the protective wrapping from the pieces
- Locate the fixing pack and put aside
- Carefully remove the electric fire from its box and put aside



PARTS SUPPLIED

Please identify the parts listed below and ensure you have ALL the correct parts before installing the unit.

Description	Illustration	Qty
Electric Fire	(See page 1)	x 1
Template		x 1
Fixings Pack	(See Below)	x 1

FIXINGS PACK

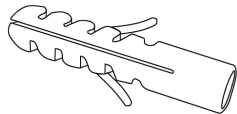
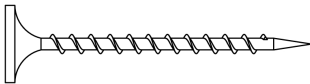
Please identify the fixings listed below and ensure you have ALL the correct fixings before installing the unit.

Description	Illustration	Qty
Wall Plug		x 2
32mm Screw		x 2
Pebble Set (ONLY FOR PEBBLE GLOW FIRES)		x 1

TOOLS REQUIRED

- Electric Drill (with 6mm masonry bit)
- Crosshead screw driver
- Spirit level
- Pencil
- Tape measure

ELECTRICAL SPECIFICATIONS

Important Electrical Safety

The socket must always be accessible in order to disconnect the fire from the electrical supply for maintenance and cleaning. Never cut off the plug and hard wire into a fixed fused spur.

Important!

- Do not spray liquids directly onto any surface of the unit.
- This fire must be earthed. The mains supply must be safely routed from the fire to an electrical socket.
- If the supply cord is damaged, it must be replaced by the manufacturer or its service agent or a similarly qualified person in order to avoid a hazard.
- This appliance is not intended for use by persons (including children) with reduced physical, sensory or mental capabilities, or lack of experience and knowledge, unless they have had supervision or instruction concerning use of the appliance by a person responsible for their safety.
- Children should be supervised to ensure that they do not play with the appliance.
- The plug must be accessible after installation to allow for isolation in an emergency.



Warning: In order to avoid overheating, **DO NOT COVER THE HEATER**

Note: Any new wiring required, must be in accordance with local and national codes and other applicable regulations in order to reduce the risk of fire, electric shock, or other injuries.

Note: When the fire is turned on for the first time or when it has not been used for some time, it may release a slight, harmless odour. This odour is a normal occurrence caused by the initial heating of the internal heating elements and will disappear with use.

MAINTENANCE

- Brushed stainless steel (silver) fires can be cleaned using a cloth and proprietary cleaner. Other features (non-silver) can be cleaned using a damp cloth.
- If the cable is damaged, it must be replaced by a suitably qualified person.
- The area around the fire should be kept free from animal hair, lint and other extraneous material that may be drawn into the workings of the appliance which could affect its performance.

SAFETY CUT-OUT SYSTEM

PLEASE DO NOT OBSTRUCT THE AIR VENTS OF THE ELECTRIC FIRE.

This appliance has a 'self resetting' safety cut out system. To prevent overheating, ensure the air inlets and outlets are not obstructed. If the safety cut-out operates, switch off the electric fire and allow to fully cool down. Remove any obstruction before re-use.

CAUTIONS

Do's	• Always install the fire in accordance with this guide. If in doubt obtain expert advice.
	• Always make sure the electrical socket is accessible and located adjacent to, but not above the fire.
	• Always disconnect the fire from the electrical supply before carrying out cleaning, maintenance or replacing the light bulbs.
	• Always make sure the fire is firmly secured.
	• Always ensure the product is assembled in an area that is free from dust, grease or liquids.
	• Always ensure that the correct tools are used to mount this fire.
	• Always make sure the fire is firmly secured to the wall when complete
Don'ts	• Never leave children unsupervised in a room where the fire is ON and unguarded.
	• Never obstruct or cover the fan outlet or force items into fire openings.
	• Never install or use the fire anywhere where water is in use, i.e. Bathrooms, Kitchens, Shower Rooms, and Swimming Pool etc.
	• Never use aerosols or steam cleaners on or around the fire.
	• Never route the mains supply cable under carpet etc.
	• Never install the fire close to curtains or combustible materials.
	• Never use the fire to dry clothes etc.
	• Never sit or stand on the fire.
	• Never lean or put weight on the fire.
	• Do not use outdoors.
	• Never cut off the plug and hard wire into a fixed fused spur.
	• Do not position furniture, curtains or other combustible material closer than 1 metre from the heater.

INSTALLATION

This fire is wall mounted and must be fixed to a wall. Please ensure the floor and wall is flat before installation.

NOTE: IT IS ADVISED THAT AN ELECTRIC SCREWDRIVER IS USED THROUGHOUT THE CONSTRUCTION AND INSTALLATION OF THIS PRODUCT

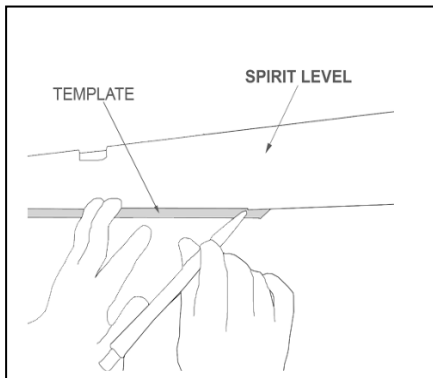

1) Using the **TEMPLATE** and a spirit level, ensure the holes on the template are level and mark through with a pencil.

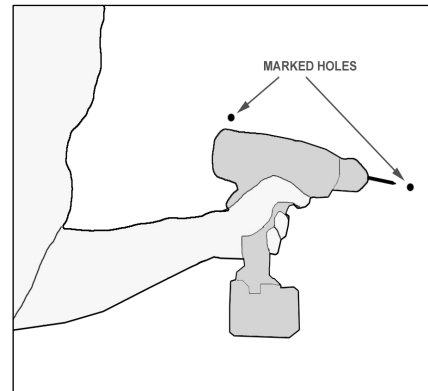

2) For solid walls, drill the 2 holes using a 6mm drill bit and fit the supplied wall plugs. **Note** if fitting the fire to plaster board with a cavity behind then propriety wall fixings (not supplied) will be required

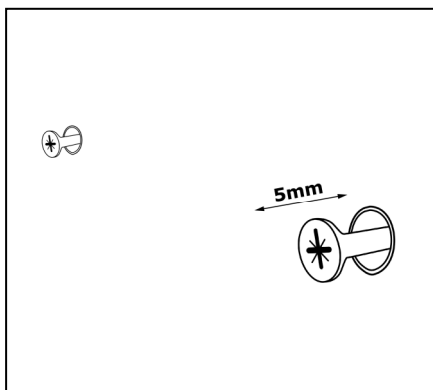

3) Screw in the 2 screws, leaving 5mm (approx) proud of wall.

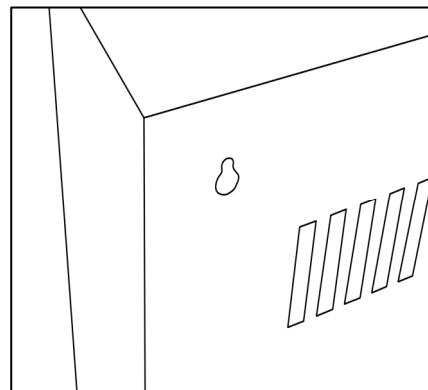

4) Hang fire using key holes on the back of the fire

PREPARING THE ELECTRIC FIRE (PEBBLE GLOW ONLY)

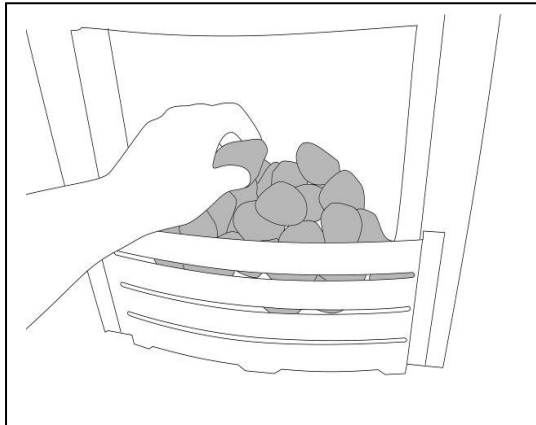

Randomly place the pebbles in the open fuel bed of the fire

OPERATING THE ELECTRIC FIRE

The appliance is controlled using 4 switches, located **under the hood of the fire**. Use the following sequence to operate. The **grey** represents a 'pressed switch.'

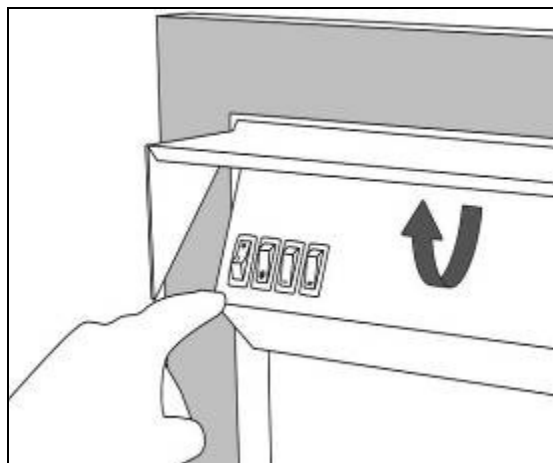

Controls located under the hood

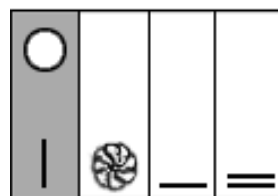

On/Off with Effect only

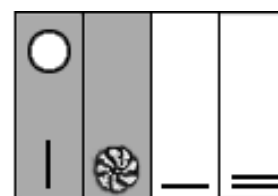

Cool Air Blow & Effect

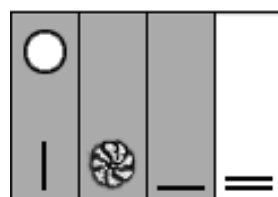

1kW Heat setting

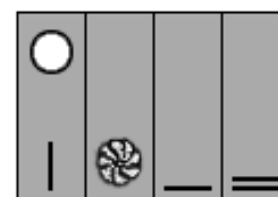

2kW Heat Setting

CHANGING THE BULB *Pebble Glow Fires*

Please ensure that the electric fire is **switched off at the mains and unplugged** before attempting to change the bulb.

Remove all pebbles before attempting to change the bulb.

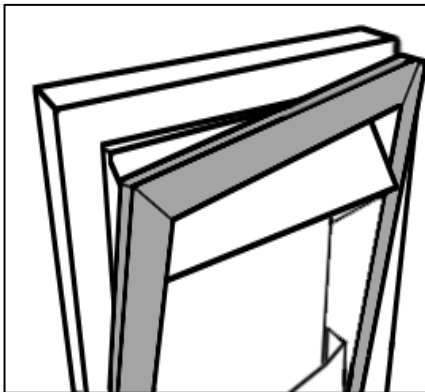

1) Remove the magnetized trim.



2) Unscrew the fret.

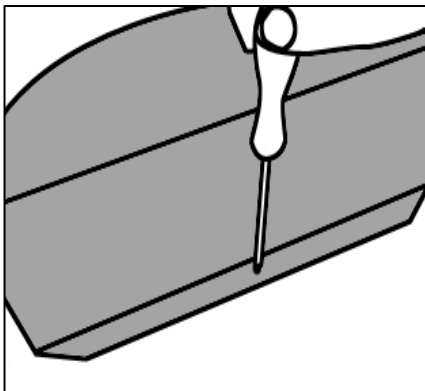

3). Unscrew the pebble bed panel.

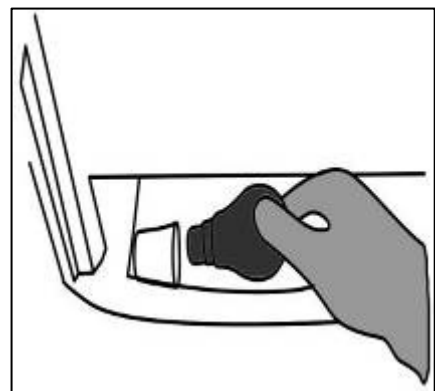

4) Unscrew the old bulb and replace with a **Pebble Glow: 40W BC bulb (MAX)**

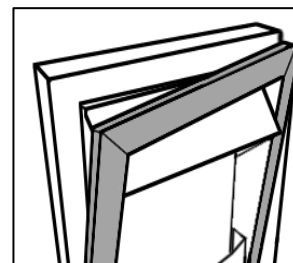
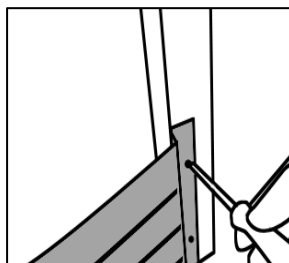
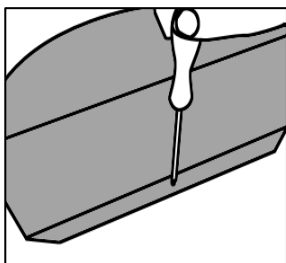

5) Replace the pebble bed, pebbles, fret and magnetized trim.

WARNING! Only replace the bulb with the same rated one (40W BC max.)

Due to their indeterminate life span, light bulbs are excluded from the guarantee.

CHANGING THE BULB *Flame Effect Fires*

Please ensure that the electric fire is **switched off at the mains and unplugged** before attempting to change the bulb.

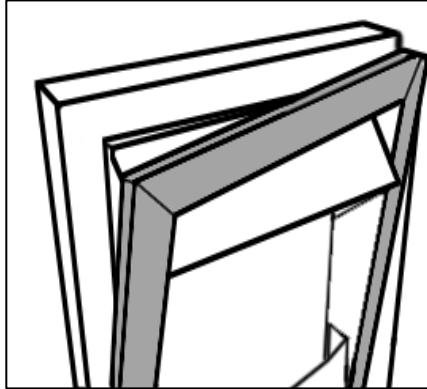

1) Remove the magnetized trim.

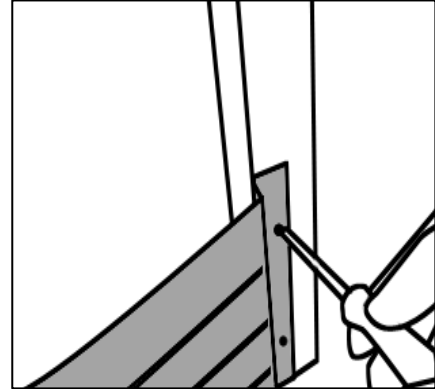

2) Unscrew the fret.

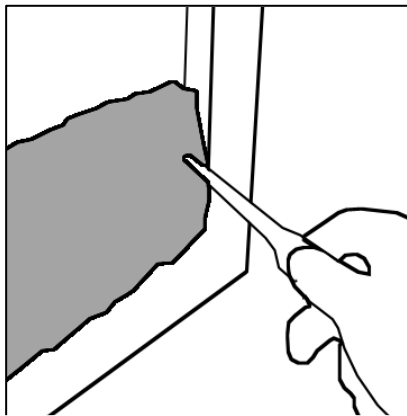

3) Unscrew the coal bed.

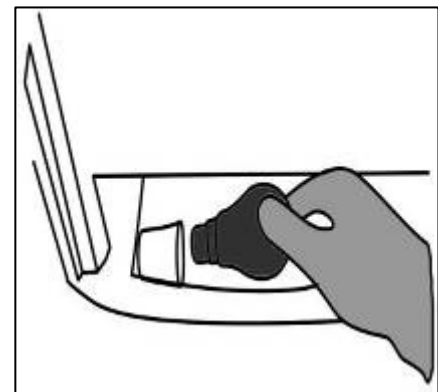

4) Unscrew the old bulb and replace with a **25W BC bulb (MAX)**.

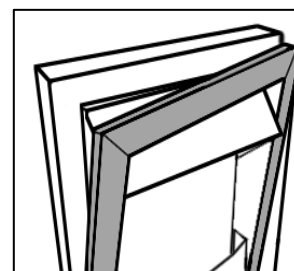
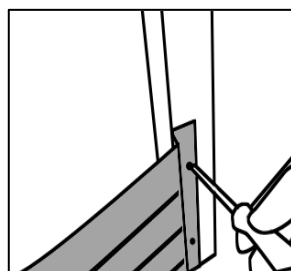
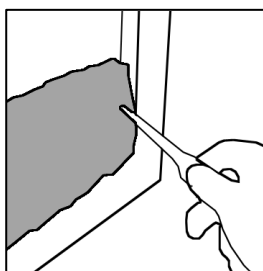

5) Replace the coal bed, fret, and magnetized trim.

WARNING! Only replace the bulb with the same rated one (25W BC max.)

Due to their indeterminate life span, light bulbs are excluded from the guarantee.

PLUG REPLACEMENT

- This appliance is supplied with a BS1363 3 pin plug fitted with a 13 Amp fuse. Should the fuse require replacement, it must be replaced with a fuse rated at **13 Amp** and approved to BS1362.
- In the event the mains plug has to be removed/replaced for any reason, please note:

The wires in the mains lead on this appliance are coloured in accordance with the following code:

Green and Yellow - **Earth**
Blue - **Neutral**
Brown - **Live**

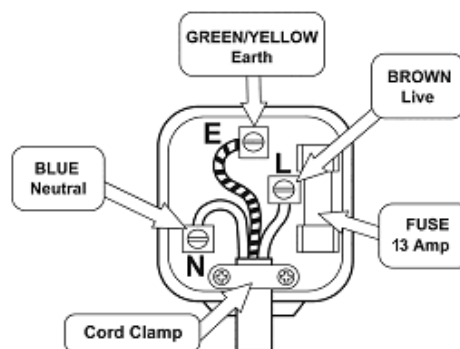

THIS APPLIANCE MUST BE EARTHED

As the colours may not correspond with the markings identifying the terminals in your plug proceed as follows.

- The green and yellow earth wire must be connected to the terminal in the plug which is marked with the letter E or with the earth symbol \perp
- The blue wire must be connected to the terminal marked N
- The brown wire must be connected to the terminal marked L

Important - any cut off plug should be disposed of safely to prevent hazard. There is a danger of electric shock if a cut off plug is inserted into a socket outlet.

APPLIANCE DATA

Flame Effect	Pebble Glow
Supply Voltage: AC 220-240V, 50Hz	Supply Voltage: 220-240V, 50Hz
Rated Power: 2000W	Rated Power: 2000W
Fuse Rating: 13 Amp	Fuse Rating: 13 Amp
Lighting: 1 x 25W BC Bulb (MAX)	Lighting: 1 x 40W BC Bulb (MAX)

CONFORMITY WITH DIRECTIVES

Conforms with relevant European Directives

ENVIRONMENTAL PROTECTION

- (WEEE) Waste Electrical and Electronic Equipment

Waste electrical products should not be disposed of with household waste. Please recycle where facilities exist. Check with your Local Authority or retailer for recycling advice.

- This appliance complies with the RoHS directive which restricts the use of certain hazardous substances in electrical and electronic equipment.

This Directive bans the placing on the EU market of new electrical and electronic equipment containing more than agreed levels of lead, cadmium, mercury, hexavalent chromium, polybrominated biphenyl (PBB) and polybrominated diphenyl ether (PBDE) flame retardants.



Adam Fires and Fireplaces is part of the Fired Up Corporation

Customer telephone helpline: 08448 809301
Helpline email address: helpline@adamsurrounds.co.uk